

MODEL RD5000

MONO-BLOCK

Directional Control Valves
1, 2, 3 Spool

Model RD5100

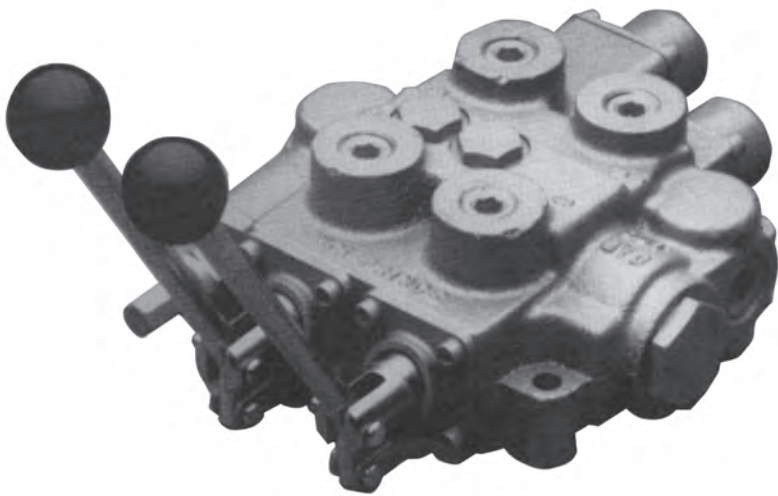
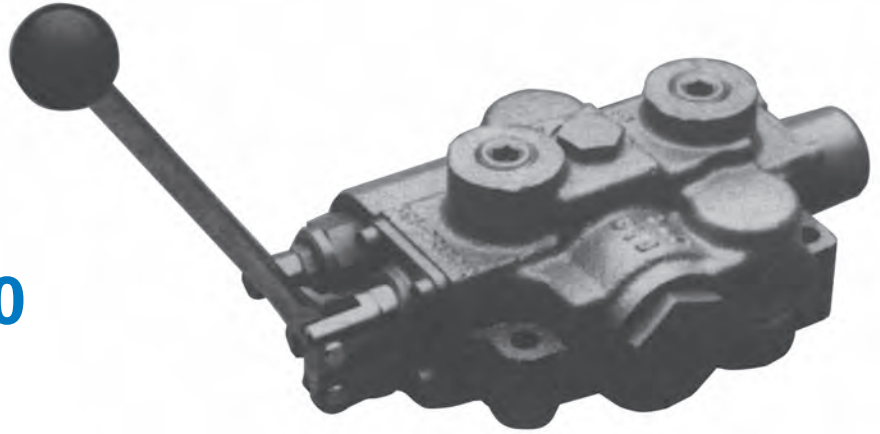

Model RD5200

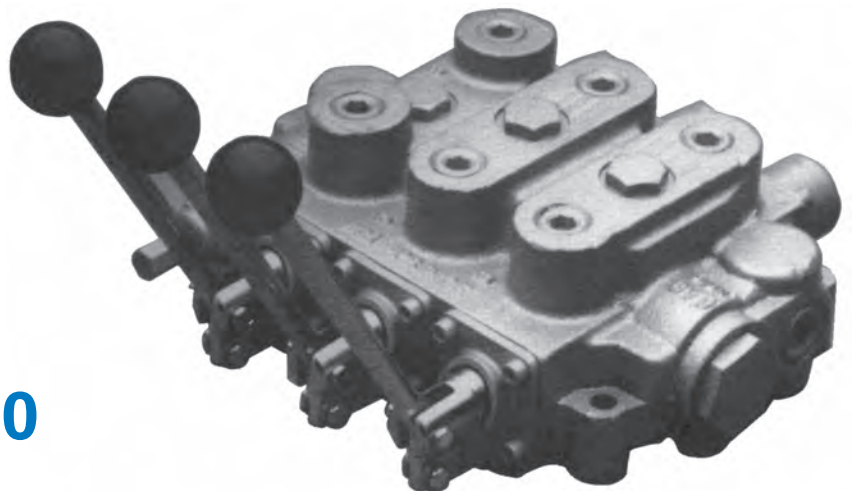

Model RD5300

MODEL RD5000 DIMENSIONAL DATA

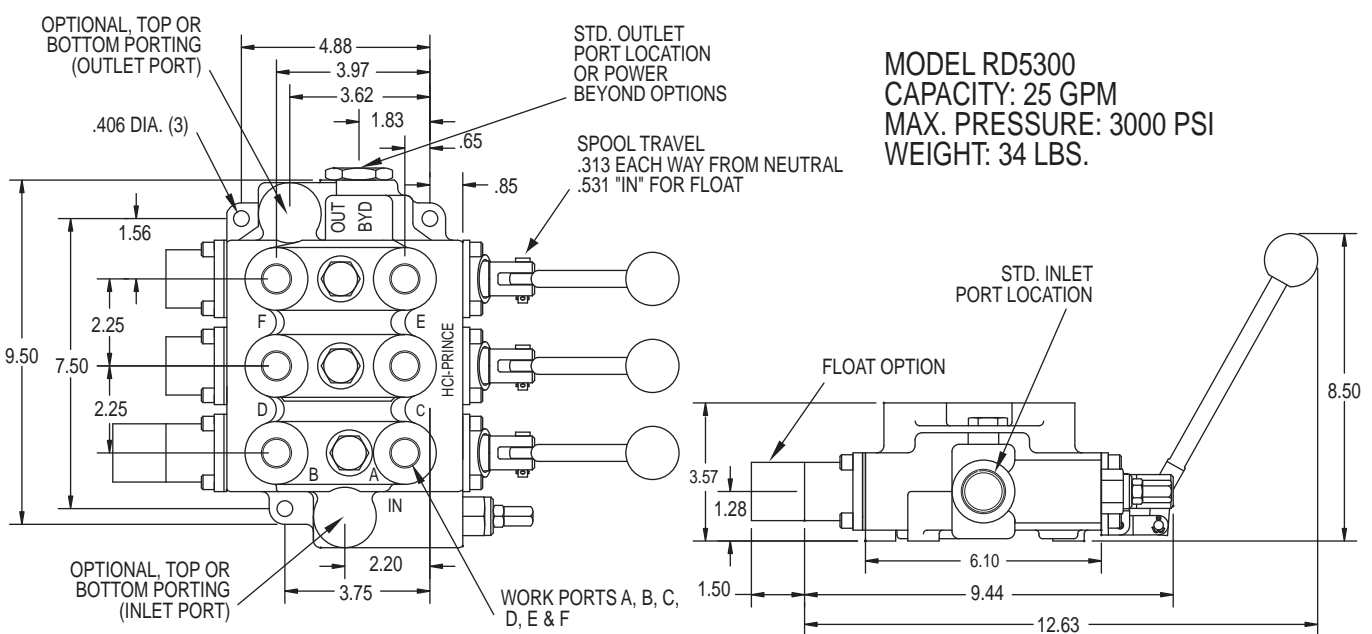
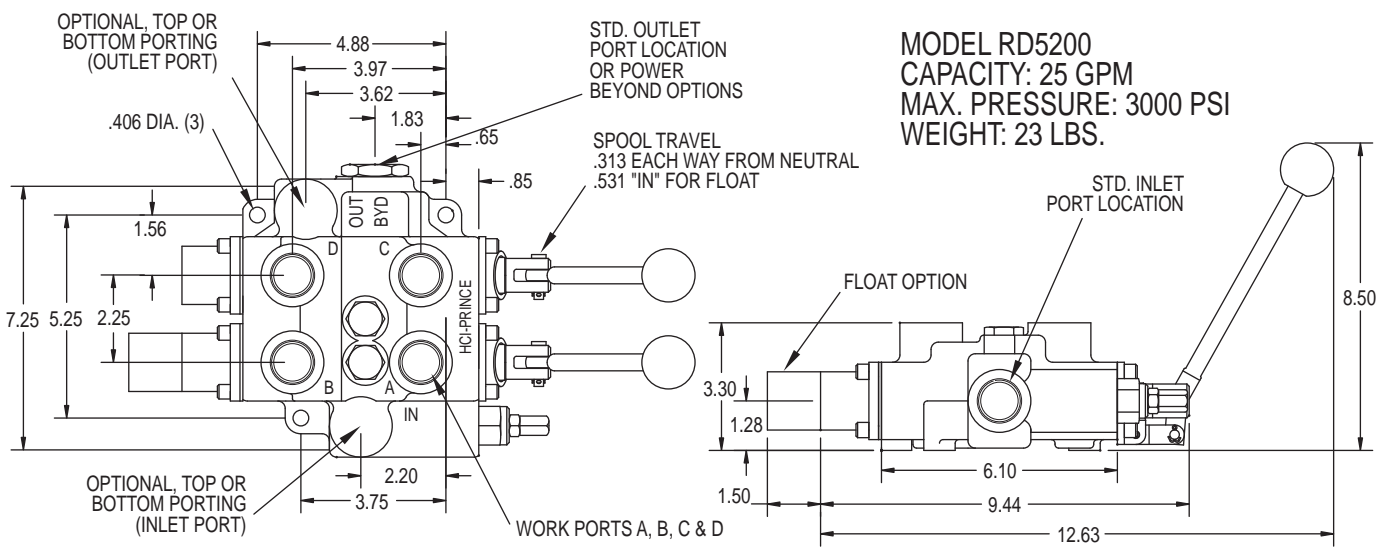
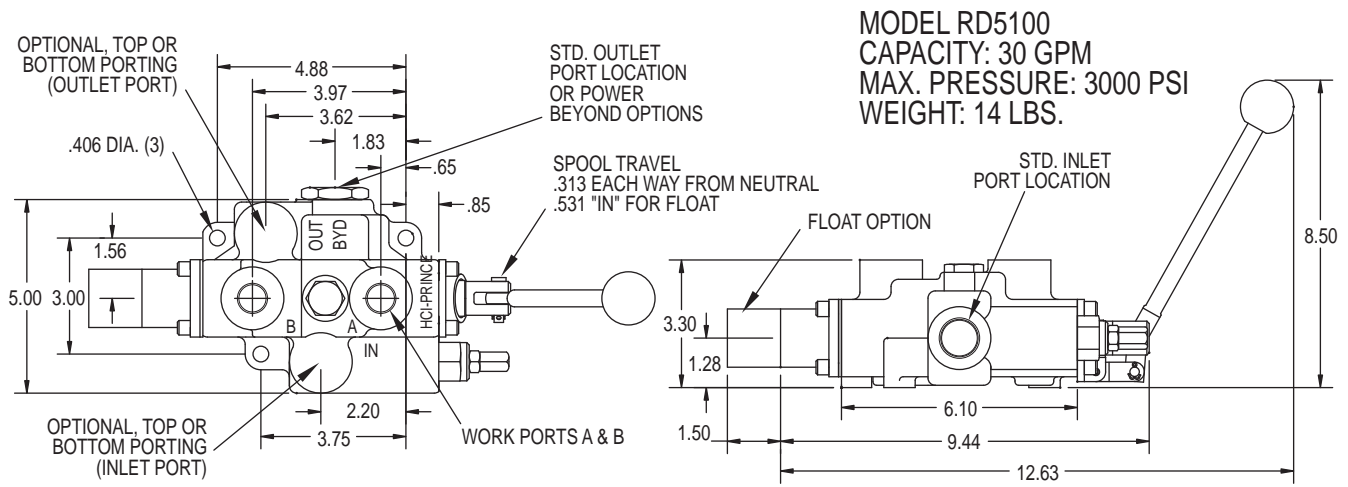

VALVES

RD5000 ORDER CODE

SPECIAL VALVES AVAILABLE:

RD5000 Mono-block Valves other than the standard models listed can be made to order. Use the order code matrix below to generate a model number that meets your requirements. Special features not listed can often be made to your specifications. A minimum order quantity may apply to special valves. Please consult your sales representative.

MODEL RD5000 ORDER CODE MATRIX:

Fill each box with one letter or number from each column to generate a model number
Note that first all spools are listed then all spool attachments.

MODEL NUMBER	PORT SIZE	SPOOL TYPE	SPOOL ATTACHMENTS	RELIEF VALVE	INLET LOCATION	OUTLET LOCATION	POWER BEYOND	HANDLE
RD51 Single Spool	2 3/4 NPTF In/Out 1/2 NPTF Work	A 3 Way, 3 Position Open Center	A 3 Position Spring Center to Neutral	1 No Relief	A End	1 END (with Power Beyond Option A)	A Not Provided (only available with outlet location 1)	1 With Complete Handle Assembly
RD52 Two Spool	3 3/4 NPTF In/Out 3/4 NPTF Work	C 4 Way, 3 Position Tandem Center	B 3 Position Detent (No Centering Spring)	2 Differential Poppet Non-Adjustable Set at 1000 PSI	B Top	2 TOP	B Conversion Plug Installed	2 Less Handle Only
RD53 Three Spool	5 #12 SAE In/Out #12 SAE Work	E 4 Way, 3 Position Open Center Motor Spool	C Friction Detent (Detented in Neutral Only)	3 Differential Poppet Non-Adjustable Set at 2000 PSI		4 END (with Power Beyond Option B, C, D, F) Standard	C Power Beyond Plug Installed with 3/4 NPTF	3 Without Handle Assembly
	6 #12 SAE In/Out #10 SAE Work	G** 4 Way, 4 Position Tandem Center Float Spool	D Rotary Actuator w/Center Detent (only available w/Handle 3 and Spool J)	4 Differential Poppet Adjustable 500-1500 PSI Set at 1000 PSI			D° Closed Center Conversion Plug Installed	RD5200 5*** Bent Joystick Handle
	Other Ports Please Specify	J 4 Way, 3 Position Tandem Center Rotary Actuator (Spool Attachment D Only)	E Pressure Release Detent 1 Position Detent, Spool "out" Only, Spring Center to Neutral	5 Differential Poppet Adjustable 1500-3000 PSI Set at 2000 PSI			F Power Beyond Plug Installed with #12 SAE	6*** Straight Joystick Handle
**Spool option "G", and spool attachment "F", and "G" are available on the first spool only. Spool option "G" must be ordered with spool attachment option "G".			H Spring Center Pneumatic Actuator	* For other Relief Settings Please Specify				Joystick can be installed on RD5300 on special order
			N 1 Position Detent Spool "out" Spring Center to Neutral					
			P 2 Position Detent Spool "in and out", Spring Center to Neutral					
			R 3 Position Spring Center with Micro-Switch and Boot (actuates with spool in or out movement)					
			S 2 Position Detent "Neutral and out", No "in" Position					

***RD532CCCAA5A4B1-25**

The last two digits are Relief pressure in hundreds
Example: 25=2500 psi, all relief settings are at 10 GPM & 105°F.

*** Joystick handle will operate both spools using only one lever handle. The two spools can be operated either independently or simultaneously depending on handle movement.

° Often used with no relief. Review application.

RD5000 PRESSURE DROP, RELIEF CURVE AND STANDARD FEATURES

STANDARD FEATURES

- * Economical monoblock construction of high tensile strength gray cast iron.
- * Load check on each spool,
- * Hard chrome plated spool.
- * Optional 4 Position Float on 1st spool.

- * Differential poppet style relief, adjustable from 1500 to 3000 psi (also available in low pressure version adjustable from 500 to 1500 psi)
- * Power beyond and closed center capability.
- * Reversible handle.

RD5100 SINGLE SPOOL VALVE PRESSURE DROP VALUES

110 SUS OIL AT 115°F			
FLOW (GPM)	Δ P-PSI		
	INLET TO OUTLET	INLET TO A OR B	A OR B TO OUTLET
5	2	8	3
10	5	17	6
15	9	35	12
20	21	58	21
25	26	86	34

RD5200 TWO SPOOL VALVE PRESSURE DROP VALUES

110 SUS OIL AT 115°F				
FLOW (GPM)	Δ P-PSI			
	INLET TO OUTLET	INLET TO WORK PORTS	A OR B TO OUTLET	C OR D TO OUTLET
5	3	11	2	2
10	8	22	8	5
15	16	38	15	11
20	28	57	27	19
25	44	83	43	29

RD5300 THREE SPOOL VALVE PRESSURE DROP VALUES

110 SUS OIL AT 115°F							
FLOW (GPM)	Δ P-PSI						
	INLET TO OUTLET	INLET TO A OR B	INLET TO C OR D	INLET TO E OR F	A OR B TO OUTLET	C OR D TO OUTLET	E OR F TO OUTLET
5	2	9	9	11	4	3	2
10	10	18	20	25	14	9	6
15	22	33	41	49	32	22	13
20	37	56	68	78	51	36	21
25	58	83	101	118	76	55	32

SPECIFICATIONS

- PARALLEL CIRCUIT (RD-5200 & RD-5300)
- MAXIMUM OPERATING PRESSURE 3000 PSI
- MAXIMUM OPERATING TEMPERATURE 180°F
- MAXIMUM TANK PORT PRESSURE 500 PSI
- RECOMMENDED SYSTEM FILTRATION...ISO 4406 19/17/14
- FLOW RATING.....
- | | |
|---------------|--|
| 30 GPM RD5100 | |
| 25 GPM RD5200 | |
| 25 GPM RD5300 | |
- WEIGHT
- | | |
|---------------|--|
| 14 LBS RD5100 | |
| 23 LBS RD5200 | |
| 34 LBS RD5300 | |

RD5000 RELIEF VALVE 110 SUS OIL AT 115°F

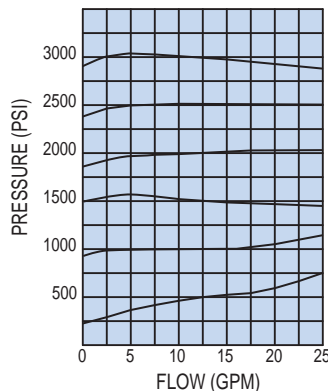

PARALLEL CIRCUIT VALVES:

Both the RD-5200 Two-Spool and RD-5300 Three-Spool Valves are parallel circuit valves. When any one of the spools is shifted it blocks off the open center passage thru the valve. The oil then flows into the parallel circuit core making oil available to all spools. If more than one spool is fully shifted then oil will go to the spool with the lowest pressure requirements. However, it is possible to meter the flow to the spool with the least load and power two unequal loads.

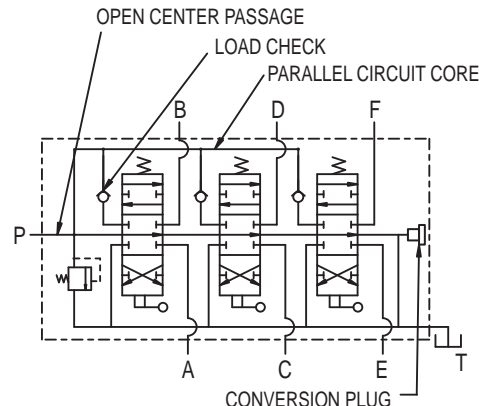

The above drawing shows a symbol for a Three-Spool Valve Model Number RD532CCCAA5A4B1

RD5000 ORDERING INFORMATION

STANDARD VALVES AVAILABLE: All standard valves have end inlet and outlet locations, power beyond conversion plug, complete handle assemblies, and adjustable differential poppet relief.

VALVE PART NUMBER	SPOOL TYPE					IN/OUT PORT SIZE	WORK PORT SIZE		RELIEF SETTING
	1st SPOOL CONFIGURATION			2nd SPOOL CONFIG.	3rd SPOOL CONFIG.		3/4 NPTF	1/2 NPTF	
	FLOAT SPOOL ¹	3 POSITION 4 WAY ²	3 POSITION 4 WAY DETENTED ³	3 POSITION 4 WAY ²	3 POSITION 4 WAY ²				
RD512GG5A4B1	X					X	X		2000 PSI @ 10 GPM
RD512CA5A4B1		X				X	X		2000 PSI @ 10 GPM
RD513GG5A4B1	X					X		X	2000 PSI @ 10 GPM
RD513CA5A4B1		X				X		X	2000 PSI @ 10 GPM
RD513CB5A4B1			X			X		X	2000 PSI @ 10 GPM
RD522GCGA5A4B1	X			X		X	X		2000 PSI @ 10 GPM
RD522CCAA5A4B1		X		X		X	X		2000 PSI @ 10 GPM
RD532GCCGA5A4B1	X			X	X	X	X		2000 PSI @ 10 GPM
RD532CCCAA5A4B1		X		X	X	X	X		2000 PSI @ 10 GPM

1. Four position, four way, tandem center, detented "in" the float position. Spring center to neutral from work positions. Work ports blocked in neutral.
2. Tandem center. Spring center to neutral from work positions. Work ports blocked in neutral.
3. Tandem center, 3 position detent. Work ports blocked in neutral.

MISC. AND FIELD CONVERSION KITS FOR MODEL RD-5000 VALVES

MATRIX CODE	MATRIX CODE	MATRIX CODE
660150001 A SPRING CENTER KIT	660250006 1 NO RELIEF PLUG	660350001 HANDLE CLEVIS
660150002 B 3 POSITION DETENT KIT	660250003 4 LOW PRESSURE ADJUSTABLE RELIEF CARTRIDGE	660551001 RD5100 SEAL KIT
660150003 C FRICTION DETENT KIT	660250002 5 HIGH PRESSURE ADJUSTABLE RELIEF CARTRIDGE	660552001 RD5200 SEAL KIT
660150018 N 1 POSITION DETENT SPOOL OUT W/ SPRING CENTER	660312005 D CLOSED CENTER CONVERSION PLUG	660553001 RD5300 SEAL KIT
660150020 P 2 POSITION DETENT W/ SPRING CENTER KIT	660150015 LOAD CHECK KIT	660150011 6 STRAIGHT JOYSTICK HANDLE KIT
660312003 B CONVERSION PLUG	660150045 R SPRING CENTER WITH MICRO-SWITCH KIT	660150012 5 45° BENT JOYSTICK HANDLE PARTS
660312004 C POWER BEYOND PLUG 3/4 NPTF	660150004 1 HANDLE HARDWARE KIT	660150014 G FLOAT HARDWARE KIT
660312008 F POWER BEYOND PLUG #12 SAE		660552002 AUTO CYCLE SEAL KIT

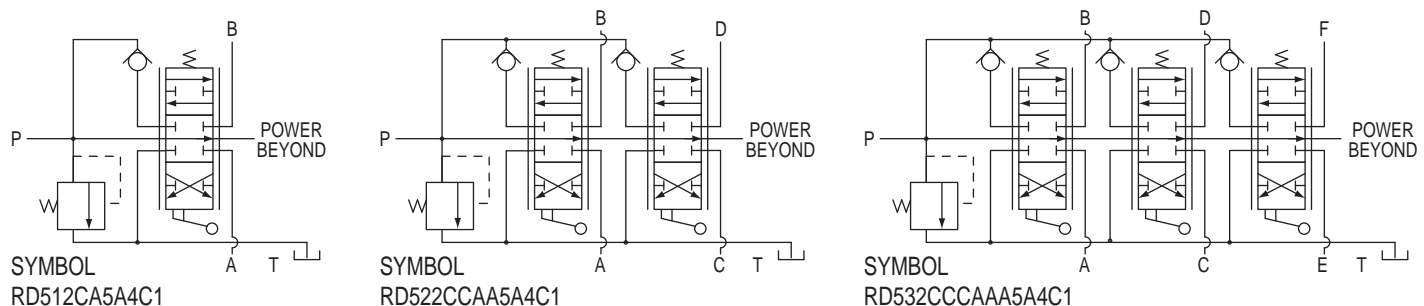

VALVES

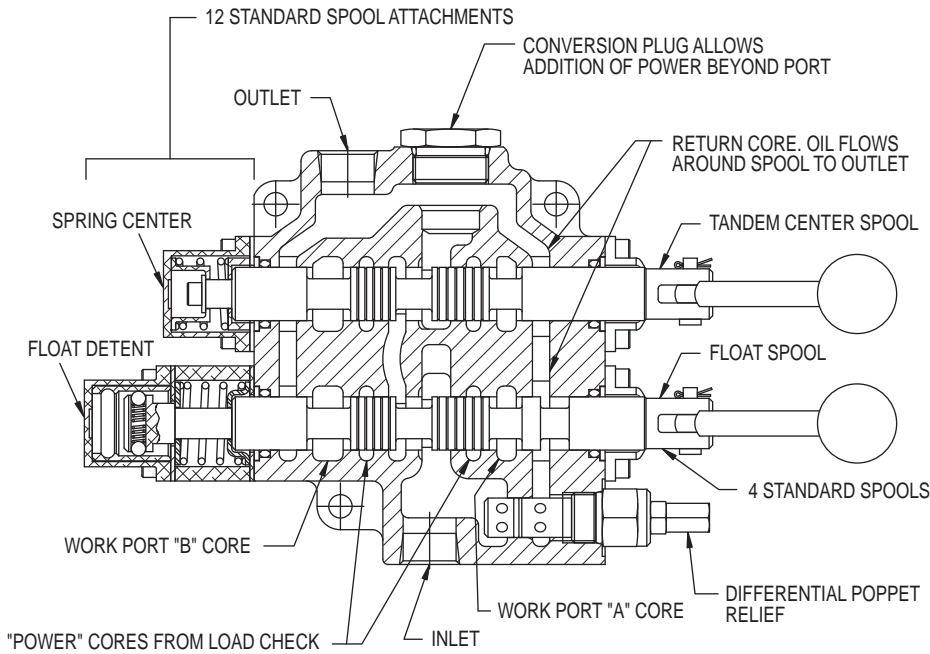

The above drawing shows a section view of a 2-spool valve, Model RD522GCGA5A4B1. This is shown as a representative valve model. Other models will differ in appearance.

TWO SPOOL "JOYSTICK" HANDLE

This handle will operate both spools using only one lever handle. The two spools can be operated either independently or simultaneously depending on handle movement.



LOAD CHECK:

The load check feature is standard on all RD-5000 series valves. Each spool has a separate load check. The load check will prevent the fall of a cylinder as the spool is shifted. It also prevents the back-flow of oil from the work port to the inlet. As shown below the pump must build up enough pressure to overcome the pressure on the work port caused by the weight of the load before the cylinder can move.

Please note that the load check has nothing to do with how well the valve will hold up a cylinder with the spool in neutral. The load check is functional only when the spool is shifted.

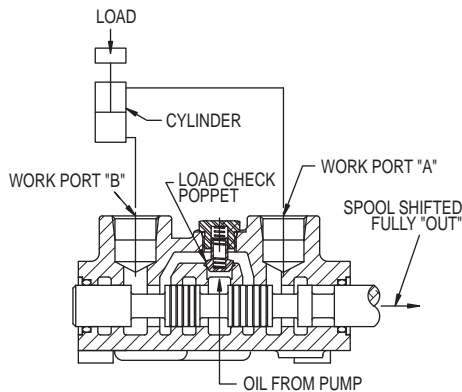

The above drawing shows a section view thru work ports of a RD-5100 Single Spool Valve.

OPEN CENTER APPLICATIONS:

The Standard RD-5000 Series Valves are open center type valves. For open center valves the hydraulic oil is directed from the inlet to the outlet, or power beyond, through the open center passage when the spools are in neutral. Moving one or more spools closes off the open center passage and directs oil to the work ports.

Open center systems most often contain fixed displacement pumps. The PMC hydraulic PTO pumps are fixed displacement gear pumps. The maximum pressure in an open center system is controlled by a relief valve. The RD-5000 series valves have a built in relief valve for this purpose.

RD-5000 Series spool options A, C, E and G are all open center spools when used with power beyond options A, B, C and F.

CLOSED CENTER APPLICATIONS:

RD-5000 Series Valves are available as closed center type valves. For closed center valves the oil through the open center passage is blocked when the spools are in neutral.

Closed center systems often use a variable displacement pressure compensated pump. When this type of pump is used in a closed center system the system pressure is controlled by the pressure compensator. When the spools of RD-5000 series valve are in neutral, system pressure is maintained at the inlet of the valve. For this reason a relief is normally not required or must be set at a higher pressure than the pump compensator. RD-5000 Series spool options C, E and G are converted to closed center by installing a closed center conversion plug, power beyond option D.

PLEASE NOTE that this closed center option does not provide for the drain off of standby spool leakage. This can allow a very small amount of oil to enter the work ports when in neutral.

RD-5000 SERIES SPOOL OPTIONS

3 WAY 3 POSITION OPEN CENTER OPTION A

This spool option is used to control a single acting cylinder or a unidirectional motor. In neutral the work port is blocked and oil goes through the open center passage to the next spool of a multi-spool valve or the power beyond of a single spool valve. The "A" port is plugged for this option.

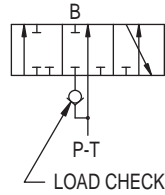

4 WAY 3 POSITION OPEN CENTER MOTOR SPOOL OPTION E

This spool option can be used to control a bi-rotational motor or a double acting cylinder. In neutral the work ports are open to the return. This allows a cylinder to drift or a motor to coast to a stop. In neutral the oil goes through the open center passage to the next spool of multi-spool valve or the power beyond of a single spool valve.

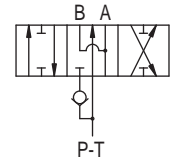

4 WAY 3 POSITION TANDEM CENTER OPTION C

This spool option is used to control a double acting cylinder or a reversible motor. In neutral both of the work ports are blocked and oil goes through the open center passage to the next spool of a multi-spool valve or the power beyond of a single spool valve. This is the most popular spool option and is used on most Prince standard valves.

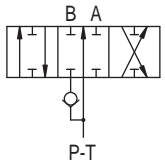

4 WAY 3 POSITION CLOSED CENTER MOTOR SPOOL

This option is similar to spool option E except in neutral the open center passage is blocked. This function is achieved by using spool option E with a closed center conversion plug (Power beyond option D).

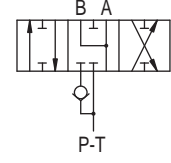

4 WAY 3 POSITION CLOSED CENTER

This spool option is similar to spool option C above except in neutral the open center passage is blocked. This function is achieved by using spool option C with a closed center conversion plug (Power beyond option D).

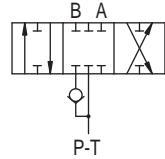

4 WAY 4 POSITION OPEN CENTER FLOAT SPOOL OPTION G

This option is the same as spool option C, 4 way 3 position tandem center, with an added fourth "float" position. In neutral the work ports are blocked (this will hold up a cylinder) and the oil goes through the open center passage to the next spool or power beyond. In the float position the work ports are open to the return (this will allow a cylinder to drift or "float") and the oil goes to next spool or power beyond. The float position is reached by pushing the spool as far as it will go and is held in place by a detent. This option must be ordered with spool action option G.

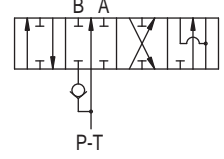

RD-5000 SERIES SPOOL ATTACHMENT OPTIONS

3 POSITION SPRING CENTER TO NEUTRAL OPTION A

This option has 3 positions and a spring that returns the spool to neutral when the handle is released. This option is considered standard on many Prince valve models.

This option can be converted in the field to 3 position detent by ordering Kit 660150002. It can be converted to friction detent by ordering Kit 660150003.

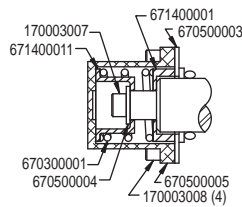

PRESSURE RELEASE DETENT, DETENT SPOOL 'OUT ONLY, SPRING CENTER TO NEUTRAL OPTION E

This option provides a pressure release detent for the spool 'Out' position. When the spool is manually placed in the detent position oil is directed to the 'B' work port (the port away from the handle). When the pressure in the 'B' port reaches a preset level the detent will release and the spool will center. The detent release pressure is factory set at 1400 psi. This pressure is adjustable from 1000 to 2000 psi. The detent release pressure is adjusted by turning the adjusting screw clockwise to increase the pressure and counter-clockwise to decrease the pressure. The spool is spring centered to neutral from the spool 'In' position. This option can be used with spool options A, C or E.

This option **can not** be added to a valve in the field.

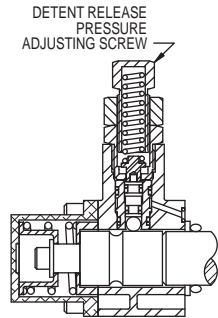

3 POSITION DETENT OPTION B

This option provides three detented positions. The spool will remain in any of the three positions in which it is manually placed. No centering spring is provided. Note: This option does not positively lock the spool in place. Excessive vibration or shock loads may effect operation.

This option can be converted in the field to spring center by ordering Kit 660150001. It can be converted to friction detent by ordering Kit 660150003.

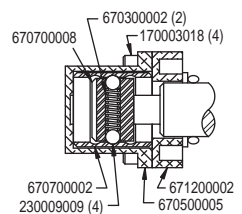

PRESSURE RELEASE DETENT, DETENT SPOOL 'IN' AND 'OUT' SPRING CENTER TO NEUTRAL OPTION F

This option is similar to option 'E' above except the pressure release detent function is on both the spool 'In' and 'Out' positions. This option is available on RD-5100 valve and number 1 spool of RD-5200 and RD-5300 valves.

This option can be used with spool options C or E. This option **can not** be added to a valve in the field.

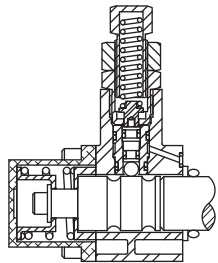

FRICITION DETENT OPTION C

This option provides for a detent in the neutral position only. As the spool is manually moved away from the neutral position it will be held in place by the friction of the detent balls on the detent sleeve. Note: Because the spool is held in place by friction only, excessive vibration may cause spool to move when not in the neutral detented position.

This option can be converted in the field to spring center by ordering Kit 660150001 and to 3 position detent by ordering Kit 660150002.

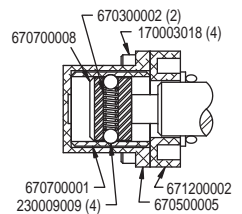

4 POSITION SPRING CENTER TO NEUTRAL DETENT SPOOL 'IN' FOR FLOAT POSITION OPTION G

This attachment is used with spool option 'G'. This option provides for spring center to neutral from either work position. It also provides a 4th position, float detent. The float detent is reached by pushing the spool in as far as it will go. In the float position both work ports are open to return. This allows a cylinder to drift or "float".

This option is available only with spool option 'G' and cannot be added to a valve in the field.

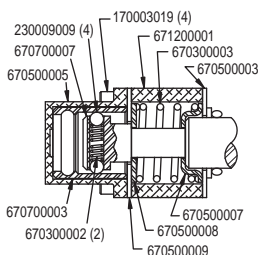

1 POSITION DETENT SPOOL 'OUT' SPRING CENTER TO NEUTRAL OPTION N

This option uses the same parts as option E above but is not pressure released. The handle must be manually removed from the detent position. The detent holding force is adjustable.

2 POSITION DETENT SPOOL 'IN' AND 'OUT' SPRING CENTER TO NEUTRAL OPTION P

This option uses the same parts as option F above but is not pressure released. The handle must be manually removed from the detent position. The detent holding force is adjustable.

VALVES

RD-5000 SERIES POWER BEYOND OPTIONS

ROTARY ACTUATOR OPTION D

With this option, rotating the spool approximately 90° clockwise from neutral moves the spool to the full in position, 90° counter clockwise to full out. There is a detent in the neutral position, and in this position, the spool clevis opening is approximately vertical. A handle is not included. This option cannot be added in the field.

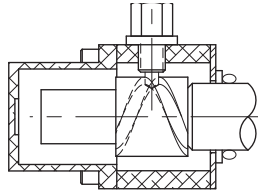

2 POSITION DETENT, NEUTRAL AND SPOOL OUT

This option provides 2 detented position, neutral and spool out. The spool is prevented from going into the "spool in" position. The spool will remain in the detented position in which it is manually placed. The option does not positively lock the spool in place and excessive vibration or shock loads may affect the operation. The three position detent kit can be converted into this option by ordering part No. 671200006.

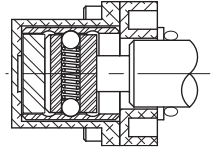

POWER BEYOND NOT PROVIDED OPTION A

This option provides an outlet only with no provision for power beyond. This option can be used with any open center spools where there is no need for a power beyond port. The end outlet, shown at right, is considered standard but a top or bottom outlet can also be specified.

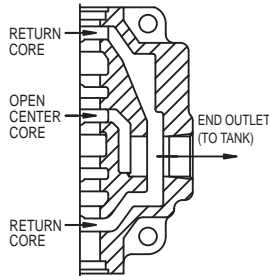

When all the valves spools are in neutral oil goes through the open center core to the outlet.

This option cannot be converted in the field to have power beyond. It also cannot be converted from open to closed center.

POWER BEYOND PLUG INSTALLED OPTION C 3/4 NPTF POWER BEYOND PORT OPTION F #12 SAE POWER BEYOND PORT

This option provides both an outlet and a power beyond port (also referred to as a high pressure carry over port). This allows another valve to be connected downstream. When all the spools of a RD-5000 series valve are in neutral high pressure oil can go through the open center core and out the power beyond port to the inlet of downstream valve. The downstream valve only receives oil when all spools of the first valve are in neutral. This option must be used with open center spools and the outlet of valve must be connected to tank.

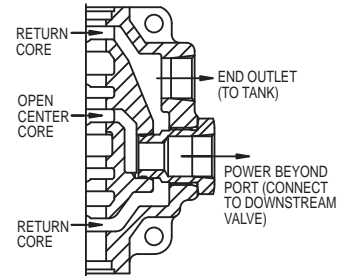

OPTION C Plug No. 660312004
OPTION F Plug No. 660312008

If the power beyond port is not used on a valve in an open center system the power beyond port must be connected to tank or the power beyond plug replaced with conversion plug 660312003.

A valve with power beyond can be converted to closed center by plugging the power beyond port or installing closed center plug 660312005.

CONVERSION PLUG INSTALLED OPTION B

This option is similar in function to Option 'A' above except the conversion plug is installed in the power beyond location and the end outlet is relocated. This option should be used with the open center spool options and allows the valve to be converted to have power beyond function or be converted from open to closed center. This option is considered the **PMC Standard** power beyond option because of the flexibility it adds to the valve.

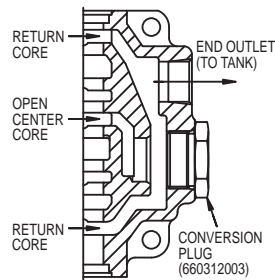

When all the valve spools are in neutral oil goes through open center core to return core and then to outlet.

To convert a valve in the field to have power beyond, remove the conversion plug and replace it with one of the power beyond plugs listed. To convert valve to closed center, replace conversion plug with closed center plug 660312005.

CLOSED CENTER CONVERSION PLUG INSTALLED OPTION D

This option converts an otherwise open center valve to closed center operation. The open center core is blocked by the conversion plug. Oil cannot pass through the valve when the spools are in neutral. Closed center systems are normally associated with variable displacement pumps or any other system where the pump flow is unloaded when system pressure is reached.

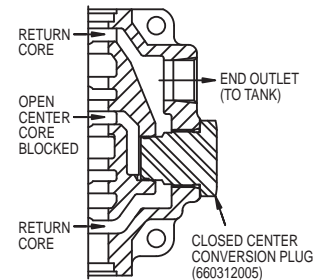

Note: If the closed center plug is installed in a valve that has a relief it may be necessary to install the no relief plug or adjust the relief pressure above the compensator setting.

Also, this closed center option does not provide for the drain off of standby spool leakage. This can allow a very small amount of oil to enter the work ports when in neutral.

RD-5000 2 SPOOL SPECIAL APPLICATION VALVE

"AUTO-CYCLE" TWO SPOOL VALVE

This valve is a modified RD-5200 two spool valve that can be used to automatically cycle a hydraulic cylinder. The spools and the valve body have been modified to provide this function. Both spools have the pressure release detent spool attachment. The valve is shown connected to a cylinder in the sketch below. The "B" port is connected to the base of the cylinder. The "A" and "D" ports are tied together and connected to the rod end of the cylinder. The "C" port is plugged. At the beginning of the cycle the cylinder is fully retracted. To begin the cycle both handles are pulled back. Oil is directed to the "B" port and the cylinder will extend until it reaches the end of its stroke. At this point the pressure will build to the detent release pressure and the first spool will center to neutral. Now the oil will go through the open center core to the second spool and is directed out the "D" port to retract the cylinder. When the cylinder reaches the full retract position the pressure will build to the detent release pressure and the second spool will center to neutral. This completes the cycle. To begin the next cycle both handles are again manually pulled back. Please note this valve does not have the loadcheck feature of the standard RD5200 valve. Also the "B" port is open to tank in neutral.

Model Number RD523MMEE5A1A1

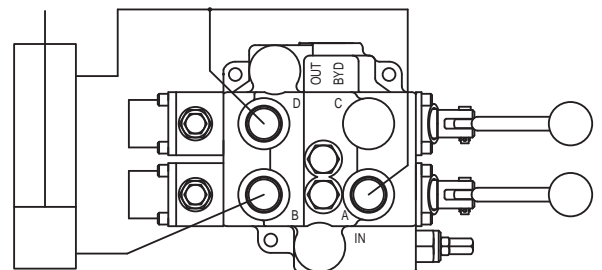

SOLENOID OPERATED RD5000 DIRECTIONAL CONTROL VALVE

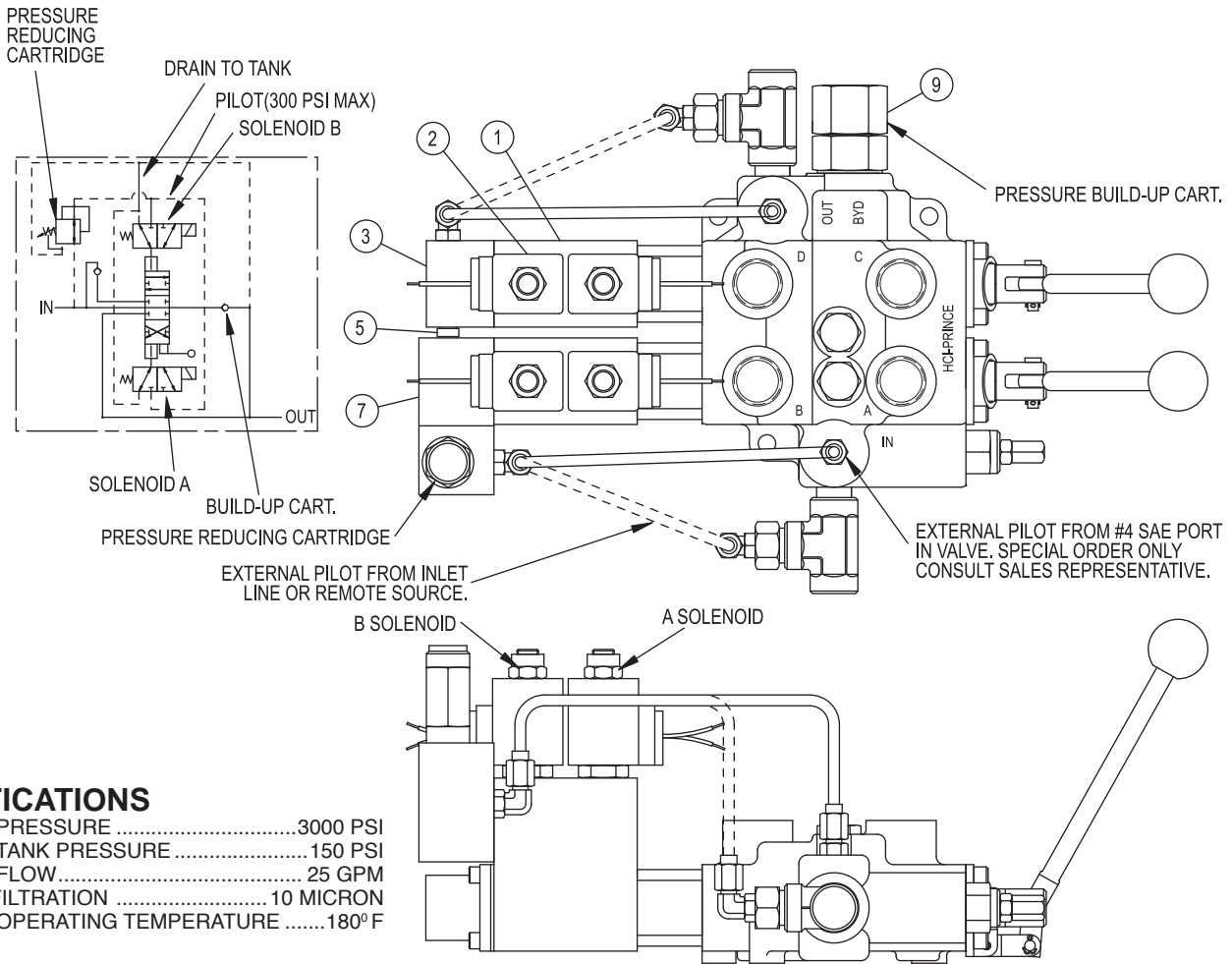

SPECIFICATIONS

MAXIMUM PRESSURE	3000 PSI
MAXIMUM TANK PRESSURE	150 PSI
MAXIMUM FLOW	25 GPM
MINIMUM FILTRATION	10 MICRON
MAXIMUM OPERATING TEMPERATURE	180° F

The Solenoid Operated RD5000 Directional Control Valve allows remote electrical on-off or manual control. This feature can be installed on the RD5100, RD5200, or RD5300. It can be installed on one or all spools of the RD5200 or RD5300. This option can be purchased as kits and installed by customer. Complete valves are available special order only (min. qty. 25) Consult your sales representative.

ITEM	QTY	PART NUMBER	DESCRIPTION
1	1	660150030	BASE ACTUATOR KIT
2	2	SEE CHART	SOLENOID COIL
3	1	660150037	END MANIFOLD KIT
4	1	660150033	MID SECTION MANIFOLD KIT
5	1	660150035	MANIFOLD TUBE KIT (SHORT)
6	1	660150036	MANIFOLD TUBE KIT (LONG)
7	1	660150046	PRES. RED. MAN. KIT (MULTI-SPOOL)
8	1	660150047	PRES. RED. MAN. KIT (SINGLE-SPOOL)
9	1	SEE CHART	PRES. BUILD-UP CART.

DESCRIPTION	PART NUMBER
PRES. BUILD-UP CART. OPEN CENTER	660312012
PRES. BUILD-UP POWER BEYOND CART (#12 SAE)	660312014
12 VDC LEAD WIRE COIL	671302003
12 VDC DOUBLE SPADE COIL	671322004
12 VDC WEATHER PACK	671302013
12 VDC DIN 43650 COIL	671302002
24 VDC LEAD WIRE COIL	671302007
24 VDC DOUBLE SPADE COIL	671322008
24 VDC DIN 43650 COIL	671302006
120 VAC CONDUIT COIL	671302009
120 VAC DIN 43650 COIL	671302010

The Solenoid Operated RD5000 contains two, 3 way-2 position solenoid cartridge valves and a pilot operated piston attached to the main control spool. When both solenoids are de-energized both sides of the pilot piston are open to tank pressure and the spool remains spring centered. When solenoid A is energized, pilot pressure is applied to one side of the pilot piston causing the spool to shift from the neutral position to work port A. When solenoid "B" is energized, pilot pressure is applied to the other side of the pilot piston causing the spool to shift to work port "B". In cases where the pilot pressure is provided by the inlet line or #4 SAE port on valve, a "Pressure Build-Up Valve" must be installed in the outlet port. Two versions of the pressure build-up valve are offered. The open center pressure build-up valve and the power beyond pressure build-up valve. Both versions supply 150-200 PSI pilot pressure to the solenoid actuator. When remote pilot is used, the pressure build-up is not required. Because the valve is internally piloted, overcenter or light loads can be a problem. The inlet pressure must be at least 200 psi during operation. Restrictors can be added to eliminate this problem.