



# THE MAJESTIC LINE

## 2500 PSI TIE-ROD DOUBLE ACTING

### THE "MAJESTIC LINE" Tie-Rod-DA-Medium Duty Rods



#### FEATURES:

- Honed tubing
- Chromed, ground & polished piston rod will operate at full pressure through 16" stroke
- Ductile iron piston, butt, gland & clevis
- Urethane u-cup & urethane wiper in gland
- Pins, clips & cotters included
- Standard color is red
- Stroke control may be installed on 8" strokes
- Side ports available on request at no additional cost

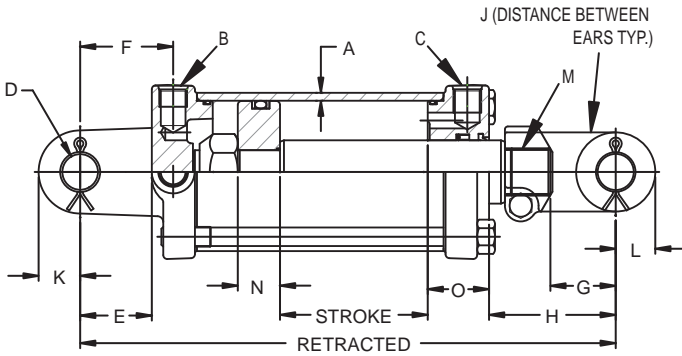

**CYLINDER DIMENSIONAL FEATURES:** For dimensional data of configured cylinders, please refer to the Standard Dimensions column of the standard cylinder tables on page C12-C13. For outside cylinder dimensions and clevis widths for both A & B models, see table below.

Bore Size	Outside Sq. Dim		Clevis Width	
	Butt	Gland	Butt	Rod
2"	2.875"	2.875"	2.375"	2.500"
2.5"	3.375"	3.375"	2.344"	2.500"
3"	3.875"	3.875"	2.375"	2.500"
3.5"	4.313"	4.313"	2.625"	2.875"
4"	5.063"	5.063"	2.750"	2.875"
4.5"	5.500"	5.500"	2.938"	2.875"
5"	5.875"	5.875"	2.938"	2.875"

Rods are sized for a maximum safe push load (2:1 safety factor) given in the table. This is based on the pin configuration shown with no center support.

Model No.	Style	Wt.	PSI	Column Load (Lbs.)	Re-tract	Rod Dia.	A SAE	B SAE	C SAE	D	E	F	G	H	J	K	L	M	N	O
SAE-8404	2 x 4	18	2500	FULL PSI	14 1/4	1	1/8	3/4-16	3/4-16	1.015	1 13/16	2 3/8	1 13/16	3 1/2	1.06	15/16	1 1/8	1-14	7/8	2 1/4
SAE-8406	2 x 6	19	2500	FULL PSI	16 1/4	1	1/8	3/4-16	3/4-16	1.015	1 13/16	2 3/8	1 13/16	3 1/2	1.06	15/16	1 1/8	1-14	7/8	2 1/4
SAE-8408	2 x 8	20	2500	FULL PSI	20 1/4	1	1/8	3/4-16	3/4-16	1.015	1 13/16	2 3/8	1 13/16	5 1/2	1.06	15/16	1 1/8	1-14	7/8	2 1/4
SAE-8410	2 x 10	21	2500	FULL PSI	20 1/4	1	1/8	3/4-16	3/4-16	1.015	1 13/16	2 3/8	1 13/16	3 1/2	1.06	15/16	1 1/8	1-14	7/8	2 1/4
SAE-7006	2 1/2 x 6	22	2500	FULL PSI	16 1/4	1 1/8	1/8	3/4-16	3/4-16	1.015	1 7/8	2 13/32	1 13/16	3 1/2	1.06	15/16	1 1/8	1 1/8-12	1	2 3/8
SAE-7008	2 1/2 x 8	23	2500	FULL PSI	20 1/4	1 1/8	1/8	3/4-16	3/4-16	1.015	1 7/8	2 13/32	1 13/16	5 1/2	1.06	15/16	1 1/8	1 1/8-12	1	2 3/8
SAE-7106	3 x 6	24	2500	FULL PSI	16 1/4	1 1/8	3/16	3/4-16	3/4-16	1.015	1 7/8	2 7/16	1 3/16	3 3/4	1.06	15/16	1 1/8	1 1/8-12	1	1 15/16
SAE-7108	3 x 8	26	2500	FULL PSI	20 1/4	1 1/8	3/16	3/4-16	3/4-16	1.015	1 7/8	2 7/16	1 3/16	5 3/4	1.06	15/16	1 1/8	1 1/8-12	1	1 15/16
SAE-7208A	3 1/2 x 8	31	2500	FULL PSI	20 1/4	1 1/8	3/16	3/4-16	3/4-16	1.015	1 7/8	2 7/16	1 13/16	5 7/8	1.06	1 1/4	1 1/4	1 1/8-12	1	1 13/16
SAE-8608	4 x 8	42	2500	FULL PSI	20 1/4	1 1/2	3/16	3/4-16	3/4-16	1.015	1 3/4	2 7/16	1 7/8	5 1/4	1.06	1 1/4	1 1/4	1 1/2-12	1	1 13/16
SAE-8610	4 x 10	45	2500	FULL PSI	20 1/4	1 1/2	3/16	3/4-16	3/4-16	1.015	1 3/4	2 7/16	1 7/8	3 1/4	1.06	1 1/4	1 1/4	1 1/2-12	1	1 13/16
SAE-8208	5 x 8	64	2500	FULL PSI	20 1/4	1 3/4	1/4	7/8-14	7/8-14	1.265	1 3/4	2 5/8	2	4	1.06	1 1/4	1 1/4	1 1/2-12	1	2 1/2
SAE-8210	5 x 10	67	2500	FULL PSI	22 1/4	1 3/4	1/4	7/8-14	7/8-14	1.265	1 3/4	2 5/8	2	4	1.06	1 1/4	1 1/4	1 1/2-12	1	2 1/2

### 3000 PSI Tie-Rod-DA-With 2" Rod

Model No.	Style	Wt.	PSI	Column Load (Lbs.)	Re-tract	Rod Dia.	A	B SAE	C SAE	D	E	F	G	H	J	K, L	M	N	O
C400080ABDDA03B	4 x 8	50	3000PSI	Full PSI	20 1/4	2	3/16	3/4 - 16	3/4 - 16	1.265	1 3/4	2 7/16	1.875	5 1/4	1.06	1 1/4	1 1/2-12	1.25	1 13/16
C400160ABDDA03B	4 x 16	68	3000PSI	Full PSI	31 1/2	2	3/16	3/4 - 16	3/4 - 16	1.265	1 3/4	2 7/16	1.875	8 1/2	1.06	1 1/4	1 1/2-12	1.25	1 13/16
C400240ABDDA03B	4 x 24	81	3000PSI	Full PSI	36 1/4	2	3/16	3/4 - 16	3/4 - 16	1.265	1 3/4	2 7/16	1.875	5 1/4	1.06	1 1/4	1 1/2-12	1.25	1 13/16
C400260ABDDA03B	4 x 26	84	3000PSI	Full PSI	38 1/4	2	3/16	3/4 - 16	3/4 - 16	1.265	1 3/4	2 7/16	1.875	5 1/4	1.06	1 1/4	1 1/2-12	1.25	1 13/16

## ALSO AVAILABLE FROM STOCK

A complete line of Hydraulic Directional Control Valves, Gear Pumps, LSHT Motors as well as Custom Designed Products to fit your needs.